

POWER RELAY

1 POLE - 17A Tab Terminal

FTR-K1 Series

RoHS compliant

■ FEATURES

- SPST 17A
- Low profile (height: 15.7mm)
- HIGH ISOLATION
Insulation Distance (between coil and contacts): 10mm min.
Dielectric strength: 5KV
Surge strength: 10KV
- Low coil power (400mW)
- Cadmium free contacts
- SAFETY STANDARDS
UL, CSA, VDE, SEMKO approved
UL, CSA TV-5 rating approved (1 form A type)
- RoHS Compliant
- UL F class isolation wire
- VDE Glow-wire ignitability test 775 (IEC60335-1) approved



■ ORDERING INFORMATION

[Example] FTR-K1T A K 005 T
 (a) (b) (c) (d) (e)

(a)	Series Name	FTR-K1T : FTR-K1T Series			
(b)	Tab Terminal Configuration	A	: Vertical		
		J	: Horizontal		
(c)	Coil Type / Enclosure	K	: Standard (400mW) / flux free		
(d)	Nominal Voltage	005	006	009	012
		: 5 VDC,	: 6VDC,	: 9VDC	: 12VDC
		018	022	024	028
		: 18 VDC	: 022VDC	: 24VDC	: 28VDC
		048	: 48VDC		
(e)	Contact Material	T	: AgSnO2		

Actual marking does not carry the type name : "FTR"

E.g.: Ordering code: FTR-K1CK012W

Actual marking: K1CK012W

FTR-K1 SERIES

■ PART NUMBERS

400mW type

Ordering Part Number	Series	Tab Terminal	Coil Power	Coil Voltage	Contact Material
FTR-K1TAK005T	FTR-K1T	A: Vertical	K: 400 mW	5	T: AgSnO ₂
FTR-K1TAK006T				6	
FTR-K1TAK009T				9	
FTR-K1TAK012T				12	
FTR-K1TAK018T				18	
FTR-K1TAK022T				22	
FTR-K1TAK024T				24	
FTR-K1TAK028T				28	
FTR-K1TAK048T		K: 430 mW	48		
FTR-K1TJK005T		J: Horizontal	K: 400 mW	5	
FTR-K1TJK006T				6	
FTR-K1TJK009T				9	
FTR-K1TJK012T				12	
FTR-K1TJK018T				18	
FTR-K1TJK022T				22	
FTR-K1TJK024T				24	
FTR-K1TJK028T	28				
FTR-K1TJK048T	K: 430 mW	48			

■ COIL DATA CHART

Coil Voltage	Nominal Voltage (VDC)	Max. Coil Voltage* ¹	Coil Resistance (±10%)	Must Operate Voltage* ²	Must Release Voltage* ²	Nominal Power (mW)
005	5	12.2 VDC	62 Ω	3.5 VDC	0.5 VDC	400
006	6	14.7 VDC	90 Ω	4.2 VDC	0.6 VDC	
009	9	22.0 VDC	202 Ω	6.3 VDC	0.9 VDC	
012	12	29.4 VDC	360 Ω	8.4 VDC	1.2 VDC	
018	18	44.1 VDC	810 Ω	12.6 VDC	1.8 VDC	
022	22	53.9 VDC	1,210 Ω	15.4 VDC	2.2 VDC	
024	24	58.8 VDC	1,440 Ω	16.8 VDC	2.4 VDC	
028	28	68.6 VDC	1,960 Ω	19.6 VDC	2.8 VDC	
048	48	117.6 VDC	5,360 Ω	33.6 VDC	4.8 VDC	430

Note: All values in the table are measured at 20°C.

*1: No contact current at 20°C

*2: Specified values are subject to pulse wave voltage

FTR-K1 SERIES

■ SPECIFICATIONS

Item		FTR-K1T () K	
Contact	Arrangement	1 form A	
	Material	AgSnO ₂	
	Resistance (initial)	Maximum 100 mΩ at 1 A, 6 VDC	
	Rating	17 A, 250 VAC	
	Maximum Carrying Current*1	17 A	
	Maximum Inrush Current	78A, 120VAC (lamp load)	
	Maximum Switching Rating	4,250VA	
	Maximum Switching Voltage	440 VAC	
	Minimum Switching Load*2	10 mA 5 VDC	
Coil	Nominal Power (at 20°C)	400mW (at 430mW 48V coil)	
	Operate Power (at 20°C)	200 mW (210mW at 48V coil)	
	Operating Temperature	-40°C to +105°C (no frost)	
Time Value	Operate (without diode)	Maximum 15ms (at nominal voltage, no bounce)	
	Release (without diode)	Maximum 5ms (at nominal voltage, no bounce)	
Life	Mechanical	20 x 10 ⁶ operations minimum	
	Electrical	AC Contact rating 100 x 10 ³ operations min.	
Other	Vibration Resistance	Misoperation	10 to 55 Hz, at double amplitude of 0.7 mm
		Endurance	10-55Hz, at double amplitude of 1.5 mm
	Shock Resistance	Misoperation	Min. 100m/s ² (11±1ms)
		Endurance	Min. 1,000m/s ² (6±1ms)
	Weight	Approximately 13g	

*1 Need to consider the heat from PCB when max. current is more than 10A.

*2 Minimum switching loads mentioned above are reference values. Please perform the confirmation test with the actual load before production since reference values may vary according to switching frequencies, environmental conditions and expected reliability levels.

FTR-K1 SERIES

■ INSULATION

Item	FTR-K1T	Note
Resistance (initial)	Minimum 1,000 M Ω 1 min.	at 500 VDC
Dielectric Strength	open contacts	1,000 VAC (50/60 Hz) 1 min.
	coil and contacts	5,000 VAC (50/60 Hz) 1 min.
Surge Voltage (coil and contact)	10,000 V	1.2 x 50 μ s standard wave
Clearance/Creepage	10 mm / 10 mm	
Insulation (DIN EN61810-1 VDE0435)		
Voltage	250 V	
Pollution	3	
Isolation material group	IIIa	
Isolation category / Reference voltage (VDE0110b)	C / 250 V	

■ SAFETY STANDARDS

Type	Compliance	Contact rating
		FTR-K1T ()K
UL	UL 508	Flammability: UL 94-V0 (plastics)
	E63614	17A, 277 VAC (resistive) 1 HP, 277VAC
CSA	C22.2 No. 14	1/2 HP, 125VAC
	LR 40304	TV-5, 120VAC Pilot duty: A300
VDE	0435, 0631, 0700, 0860, 40013848	17A, 250 VAC (cos ϕ =1), 105°C 3.5A, 250 VAC (cos ϕ =0.4), 105°C 12A, 250 VAC (cos ϕ =1), 125°C 5A/80A 250VAC
SEMKO	EN 61058-1:1992 and A1 EN 61095:1993 and A1+A11	250VAC, 17 (3)A 40T105

Complies with NEMKO, DEMKO, FIMKO

FTR-K1 SERIES

CHARACTERISTIC DATA

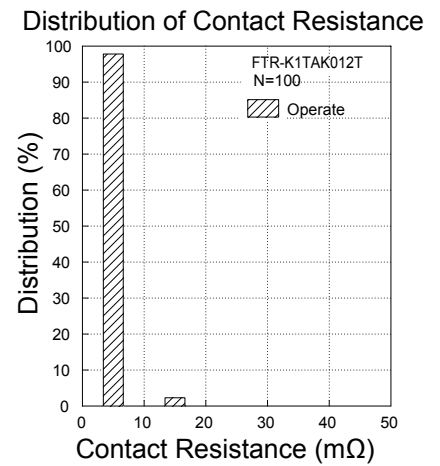
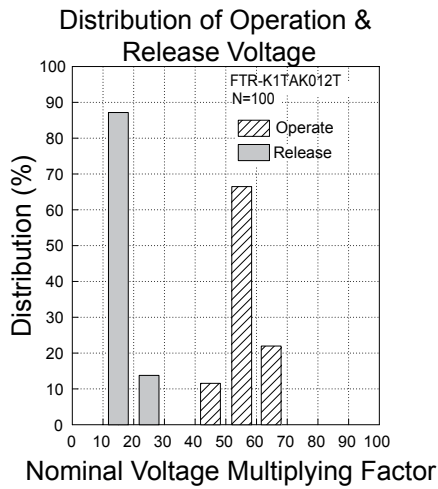
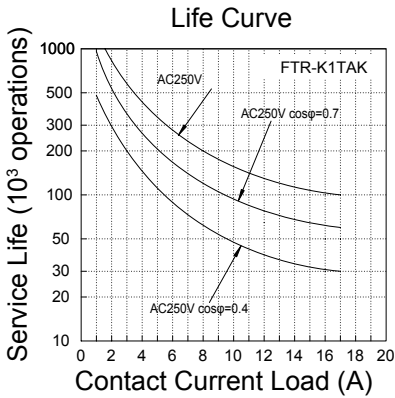
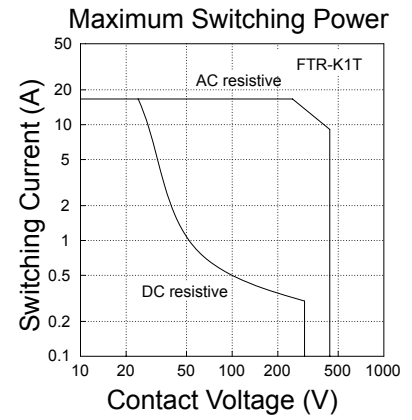
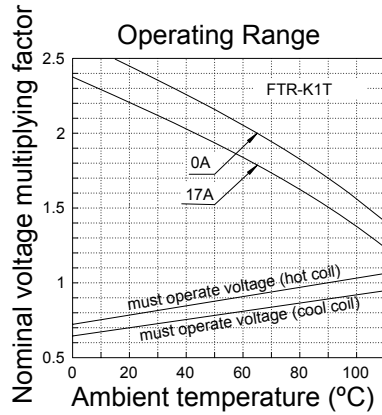
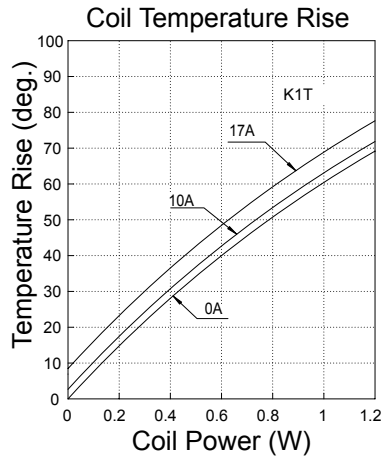

FTR-K1 SERIES

■ DIMENSIONS

● Dimensions

FTR-K1TAK

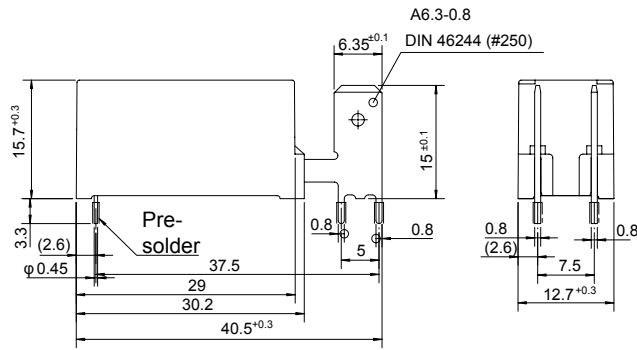

● Schematics (BOTTOM VIEW)

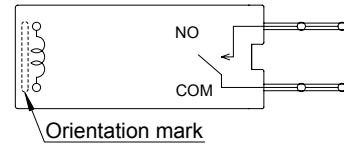

● PC board mounting hole layout (BOTTOM VIEW)

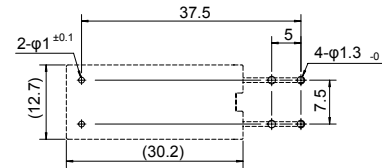

● Dimensions

FTR-K1TJK

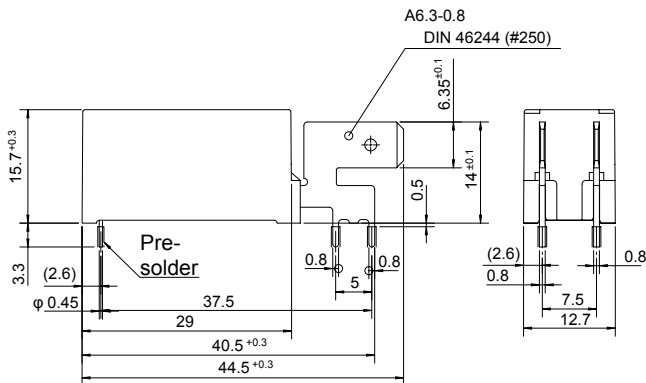

● Schematics (BOTTOM VIEW)

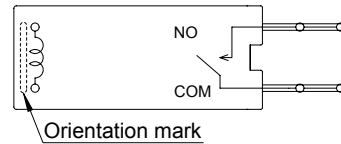

● PC board mounting hole layout (BOTTOM VIEW)

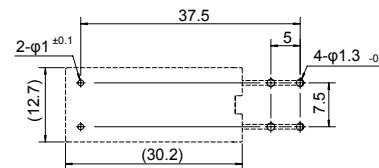

Unit: mm

RoHS Compliance and Lead Free Relay Information

1. General Information

- Relays produced after the specific date code that is indicated on each data sheet are lead-free now. All of our signal and power relays are lead-free. Please refer to Lead-Free Status Info. (<http://www.fujitsu.com/us/downloads/MICRO/fcai/relays/lead-free-letter.pdf>)
 - Lead free solder paste currently used in relays is Sn-3.0Ag-0.5Cu.
 - All signal and power relays also comply with RoHS. Please refer to individual data sheets. Relays that are RoHS compliant do not contain the 5 hazardous materials that are restricted by RoHS directive (lead, mercury, chromium IV, PBB, PBDE, DecaBDE).
 - It has been verified that using lead-free relays in leaded assembly process will not cause any problems (compatible).
 - "LF" is marked on each outer and inner carton. (No marking on individual relays).
- Note: Cadmium was exempted from RoHS on October 21, 2005. (Amendment to Directive 2002/95/EC)

2. Recommended Lead Free Solder Profile

- Recommended solder paste Sn-3.0Ag-0.5Cu.

Solder condition

Flow Solder condition:

Pre-heating: maximum 120°C
Soldering: dip within 5 sec. at
260°C solder bath

Solder by Soldering Iron:

Soldering Iron
Temperature: maximum 360°C
Duration: maximum 3 sec.

We highly recommend that you confirm your actual solder conditions

3. Moisture Sensitivity

- Moisture Sensitivity Level standard is not applicable to electromechanical relays.

4. Tin Whisker

- Dipped SnAgCu solder is known as low risk tin whisker. No considerable length whisker was found by our in house test.

Fujitsu Components International Headquarter Offices

Japan

Fujitsu Component Limited
Gotanda-Chuo Building
3-5, Higashigotanda 2-chome, Shinagawa-ku
Tokyo 141, Japan
Tel: (81-3) 5449-7010
Fax: (81-3) 5449-2626
Email: promothq@ft.ed.fujitsu.com
Web: www.fcl.fujitsu.com

North and South America

Fujitsu Components America, Inc.
250 E. Caribbean Drive
Sunnyvale, CA 94089 U.S.A.
Tel: (1-408) 745-4900
Fax: (1-408) 745-4970
Email: components@us.fujitsu.com
Web: <http://www.fujitsu.com/us/services/edevices/components/>

Europe

Fujitsu Components Europe B.V.
Diamantlaan 25
2132 WV Hoofddorp
Netherlands
Tel: (31-23) 5560910
Fax: (31-23) 5560950
Email: info@fceu.fujitsu.com
Web: emea.fujitsu.com/components/

Asia Pacific

Fujitsu Components Asia Ltd.
102E Pasir Panjang Road
#01-01 Citilink Warehouse Complex
Singapore 118529
Tel: (65) 6375-8560
Fax: (65) 6273-3021
Email: fcal@fcal.fujitsu.com
Web: <http://www.fujitsu.com/sg/services/micro/components/>

©2008 Fujitsu Components America, Inc. All rights reserved. All trademarks or registered trademarks are the property of their respective owners.

Fujitsu Components America or its affiliates do not warrant that the content of datasheet is error free. In a continuing effort to improve our products Fujitsu Components America, Inc. or its affiliates reserve the right to change specifications/datasheets without prior notice.
Rev. August 6, 2008.